

# Anillos de recubrimiento FRP

Adecuado para brida de collar GRP Rotec

Drilling Standard: JIS B2220 20K

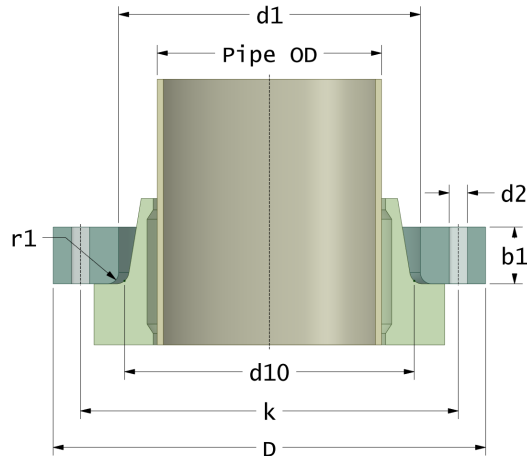
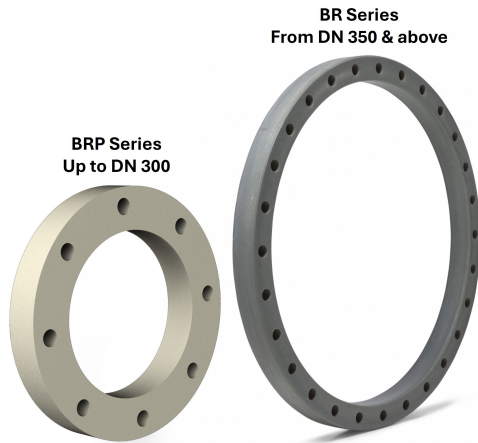

#	DN (mm)	Pmax (bar)	D (mm)	d1 (mm)	d10 (mm)	r1 (mm)	k (mm)	Holes (no.)	d2 (mm)	b1 (mm)	Resin Type	Product Color	Article Number
1	350	20	540	404	400	5	480	16	33	58	Vinylester	Grey	BR-350-404-20/20K
2	350	25	540	404	400	5	480	16	33	66	Vinylester	Grey	BR-350-404-25/20K
3	400	20	600	462	458	6	540	16	33	62	Vinylester	Grey	BR-400-462-20/20K
4	450	20	680	514	510	6	605	20	33	66	Vinylester	Grey	BR-450-514-20/20K
5	450	25	710	514	510	6	605	20	33	74	Vinylester	Grey	BR-450-514-25/20K
6	500	20	735	568	564	6	660	20	33	72	Vinylester	Grey	BR-500-568-20/20K
7	500	25	735	574	570	8	660	20	33	82	Vinylester	Grey	BR-500-574-25/20K
8	600	20	850	664	660	8	770	24	39	78	Vinylester	Grey	BR-600-664-20/20K
9	630	20	850	687	681	8	770	24	39	89	Vinylester	Grey	BR-630-687-20/20K
10	700	20	1035	764	760	8	900	24	48	84	Vinylester	Grey	BR-700-764-20/20K
11	700	25	1035	764	760	8	900	24	48	98	Vinylester	Grey	BR-700-764-25/20K
12	800	20	1150	890	886	9	1030	24	56	90	Vinylester	Grey	BR-800-890-20/20K
13	800	25	1150	890	886	9	1030	24	56	106	Vinylester	Grey	BR-800-890-25/20K
14	900	20	1270	989	985	9	1140	28	56	100	Vinylester	Grey	BR-900-989-20/20K
15	900	25	1270	989	985	9	1140	28	56	118	Vinylester	Grey	BR-900-989-25/20K

## Disclaimer

Whilst every care is taken to ensure that the information on this website is complete and accurate, the Rotec Composite Group BV cannot accept responsibility for any omissions or inaccuracies or for any consequences arising therefrom. By using this website, the user accepts the terms of this disclaimer.