

Anillos de recubrimiento FRP

Adecuado para brida de collar GRP Rotec

Drilling Standard: ANSI B16.5 Class 150

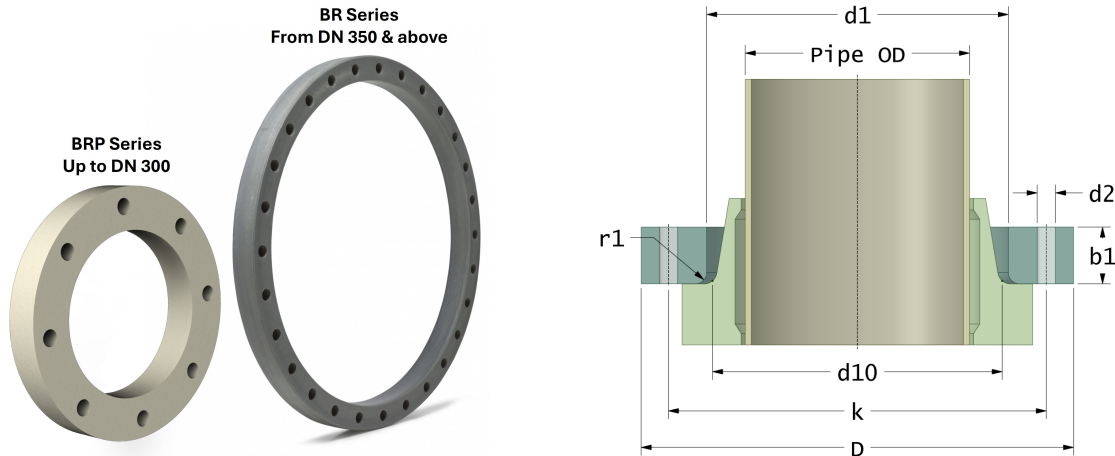

#	DN (mm)	Pmax (bar)	D (mm)	d1 (mm)	d10 (mm)	r1 (mm)	k (mm)	Holes (no.)	d2 (mm)	b1 (mm)	Resin Type	Product Color	Article Number
1	15	16	98	32	31	3	60	4	16	15	Vinylester	Off-White	BRP-15-32-16/150
2	25	16	116	45	44	3	79	4	16	15	Vinylester	Off-White	BRP-25-45-16/150
3	32	16	116	55	54	3	89	4	16	16	Vinylester	Off-White	BRP-32-55-16/150
4	40	16	140	62	61	3	98	4	16	18	Vinylester	Off-White	BRP-40-62-16/150
5	50	16	154	78	77	4	121	4	19	18	Vinylester	Off-White	BRP-50-78-16/150
6	65	16	184	96	95	4	140	4	19	20	Vinylester	Off-White	BRP-65-96-16/150
7	80	10	200	112	111	4	152	4	19	23	Vinylester	Off-White	BRP-80-112-10/150
8	80	16	200	112	111	4	152	4	19	28	Vinylester	Off-White	BRP-80-112-16/150
9	100	6	228	134	133	5	190	8	19	20	Vinylester	Off-White	BRP-100-134-06/150
10	100	10	228	134	133	5	190	8	19	25	Vinylester	Off-White	BRP-100-134-10/150
11	100	16	228	134	133	5	190	8	19	30	Vinylester	Off-White	BRP-100-134-16/150
12	125	6	254	161	160	5	216	8	22	22	Vinylester	Off-White	BRP-125-161-06/150
13	125	10	254	161	160	5	216	8	22	28	Vinylester	Off-White	BRP-125-161-10/150
14	125	16	254	161	160	5	216	8	22	34	Vinylester	Off-White	BRP-125-161-16/150
15	150	6	284	189	188	5	241	8	22	25	Vinylester	Off-White	BRP-150-189-06/150
16	150	10	284	189	188	5	241	8	22	34	Vinylester	Off-White	BRP-150-189-10/150
17	150	16	284	189	188	5	241	8	22	40	Vinylester	Off-White	BRP-150-189-16/150
18	200	6	342	238	237	6	298	8	22	32	Vinylester	Off-White	BRP-200-238-06/150
19	200	10	342	238	237	6	298	8	22	38	Vinylester	Off-White	BRP-200-238-10/150

Disclaimer

Whilst every care is taken to ensure that the information on this website is complete and accurate, the Rotec Composite Group BV cannot accept responsibility for any omissions or inaccuracies or for any consequences arising therefrom. By using this website, the user accepts the terms of this disclaimer.

Anillos de recubrimiento FRP

Adecuado para brida de collar GRP Rotec

Drilling Standard: ANSI B16.5 Class 150

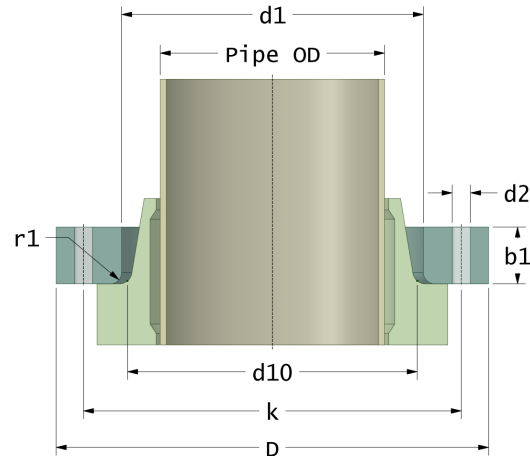
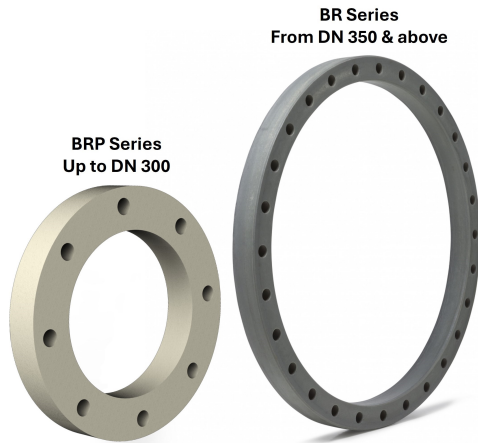

#	DN (mm)	Pmax (bar)	D (mm)	d1 (mm)	d10 (mm)	r1 (mm)	k (mm)	Holes (no.)	d2 (mm)	b1 (mm)	Resin Type	Product Color	Article Number
20	200	16	342	238	237	6	298	8	22	48	Vinylester	Off-White	BRP-200-238-16/150
21	250	6	405	294	293	6	362	12	26	34	Vinylester	Off-White	BRP-250-294-06/150
22	250	10	405	294	293	6	362	12	26	42	Vinylester	Off-White	BRP-250-294-10/150
23	250	16	405	294	293	6	362	12	26	54	Vinylester	Off-White	BRP-250-294-16/150
24	300	6	485	344	343	6	432	12	26	38	Vinylester	Off-White	BRP-300-344-06/150
25	300	10	485	344	343	6	432	12	26	52	Vinylester	Off-White	BRP-300-344-10/150
26	350	6	540	388	398	7	460	12	29	42	Vinylester	Grey	BR-350-388-06/150
27	350	10	540	404	400	5	476	12	29	38	Vinylester	Grey	BR-350-404-10/150
28	350	16	540	404	400	5	476	12	29	52	Vinylester	Grey	BR-350-404-16/150
29	400	6	600	442	438	7	540	16	29	44	Vinylester	Grey	BR-400-442-06/150
30	400	10	600	442	438	7	540	16	29	44	Vinylester	Grey	BR-400-442-10/150
31	400	10	600	462	458	6	540	16	29	40	Vinylester	Grey	BR-400-462-10/150
32	400	16	600	462	458	6	540	16	29	56	Vinylester	Grey	BR-400-462-16/150
33	450	10	644	506	502	6	578	16	32	42	Vinylester	Grey	BR-450-506-10/150
34	450	16	644	506	502	6	578	16	32	60	Vinylester	Grey	BR-450-506-16/150
35	500	3	720	558	554	6	635	20	32	32	Vinylester	Grey	BR-500-558-03/150
36	500	6	715	545	556	7	635	20	32	57	Vinylester	Grey	BR-500-545-06/150
37	500	6	720	558	554	6	635	20	32	34	Vinylester	Grey	BR-500-558-06/150
38	500	10	715	560	556	6	635	20	32	55	Vinylester	Grey	BR-500-560-10/150

Disclaimer

Whilst every care is taken to ensure that the information on this website is complete and accurate, the Rotec Composite Group BV cannot accept responsibility for any omissions or inaccuracies or for any consequences arising therefrom. By using this website, the user accepts the terms of this disclaimer.

Anillos de recubrimiento FRP

Adecuado para brida de collar GRP Rotec

Drilling Standard: ANSI B16.5 Class 150

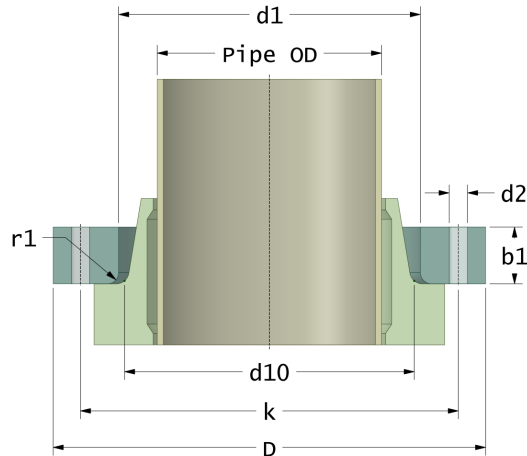
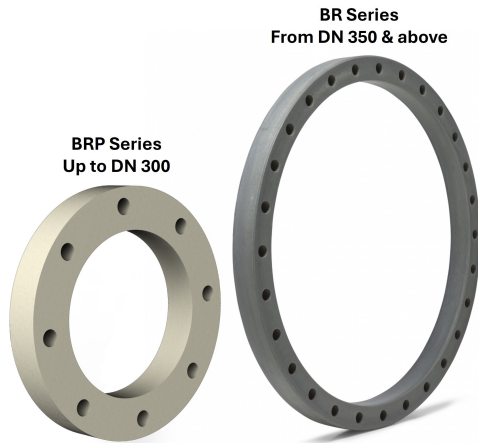

#	DN (mm)	Pmax (bar)	D (mm)	d1 (mm)	d10 (mm)	r1 (mm)	k (mm)	Holes (no.)	d2 (mm)	b1 (mm)	Resin Type	Product Color	Article Number
39	500	10	720	558	554	6	635	20	32	48	Vinylester	Grey	BR-500-558-10/150
40	500	16	715	560	556	6	635	20	32	70	Vinylester	Grey	BR-500-560-16/150
41	500	16	720	558	554	6	635	20	32	66	Vinylester	Grey	BR-500-558-16/150
42	600	3	844	650	646	8	749	20	32	62	Vinylester	Grey	BR-600-650-03/150
43	600	3	844	654	650	8	749	20	35	34	Vinylester	Grey	BR-600-654-03/150
44	600	6	844	654	650	8	749	20	35	38	Vinylester	Grey	BR-600-654-06/150
45	600	10	844	654	650	8	749	20	35	54	Vinylester	Grey	BR-600-654-10/150
46	600	16	844	654	650	8	749	20	35	72	Vinylester	Grey	BR-600-654-16/150
47	630	3	844	668	650	8	749	20	35	34	Vinylester	Grey	BR-630-668-03/150
48	630	10	844	668	650	8	749	20	35	62	Vinylester	Grey	BR-630-668-10/150
49	630	16	844	668	650	8	749	20	35	78	Vinylester	Grey	BR-630-668-16/150

Disclaimer

Whilst every care is taken to ensure that the information on this website is complete and accurate, the Rotec Composite Group BV cannot accept responsibility for any omissions or inaccuracies or for any consequences arising therefrom. By using this website, the user accepts the terms of this disclaimer.