

Rotec FRP Backing Rings

suitable for PVC Stub flange

Drilling Standard: EN1092 PN16



#	DN (mm)	Pmax (bar)	Pipe OD (mm)	D (mm)	d1 (mm)	d10 (mm)	r1 (mm)	k (mm)	Holes (no.)	d2 (mm)	b1 (mm)	Article Number
1	10	16	16	98	23	22	3	60	4	14	12	BRPVC-10-23-16/16
2	15	16	20	98	28	27	3	65	4	14	14	BRPVC-15-28-16/16
3	20	16	25	116	34	33	3	75	4	14	15	BRPVC-20-34-16/16
4	25	16	32	116	42	40	3	85	4	14	16	BRPVC-25-42-16/16
5	32	16	40	140	51	50	3	100	4	18	16	BRPVC-32-51-16/16
6	40	16	50	154	62	61	3	110	4	18	18	BRPVC-40-62-16/16
7	50	16	63	164	78	75	4	125	4	18	18	BRPVC-50-78-16/16
8	65	10	75	184	92	89	4	145	4	18	16	BRPVC-65-92-10/16
9	65	16	75	184	92	89	4	145	4	18	22	BRPVC-65-92-16/16
10	80	6	90	200	112	108	4	160	8	18	18	BRPVC-80-112-06/16
11	80	10	90	200	112	108	4	160	8	18	23	BRPVC-80-112-10/16
12	80	16	90	200	112	108	4	160	8	18	28	BRPVC-80-112-16/16
13	100	6	110	228	134	132	5	180	8	18	18	BRPVC-100-134-06/16
14	100	10	110	228	134	132	5	180	8	18	25	BRPVC-100-134-10/16
15	100	16	110	228	134	132	5	180	8	18	30	BRPVC-100-134-16/16
16	125	6	140	254	167	163	5	210	8	18	20	BRPVC-125-167-06/16

Disclaimer

Whilst every care is taken to ensure that the information on this website is complete and accurate, the Rotec Composite Group BV cannot accept responsibility for any omissions or inaccuracies or for any consequences arising therefrom. By using this website, the user accepts the terms of this disclaimer.

25-01-2024

Rotec FRP Backing Rings

suitable for PVC Stub flange

Drilling Standard: EN1092 PN16

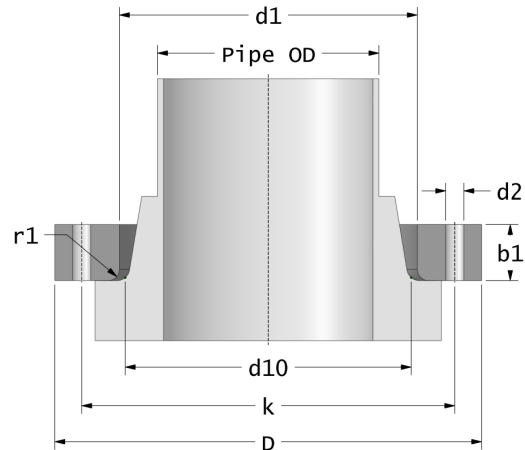

#	DN (mm)	Pmax (bar)	Pipe OD (mm)	D (mm)	d1 (mm)	d10 (mm)	r1 (mm)	k (mm)	Holes (no.)	d2 (mm)	b1 (mm)	Article Number
17	125	10	140	254	167	163	5	210	8	18	26	BRPVC-125-167-10/16
18	125	16	140	254	167	163	5	210	8	18	33	BRPVC-125-167-16/16
19	150	6	160	284	189	185	5	240	8	22	22	BRPVC-150-189-06/16
20	150	10	160	284	189	185	5	240	8	22	30	BRPVC-150-189-10/16
21	150	16	160	284	189	185	5	240	8	22	38	BRPVC-150-189-16/16
22	200	10	175	342	226	222	6	295	12	22	38	BRPVC-200-226-10/16
23	200	10	200	342	235	232	6	295	12	22	38	BRPVC-200-235-10/16
24	200	10	225	342	252	248	6	295	12	22	38	BRPVC-200-252-10/16
25	200	16	175	342	226	222	6	295	12	22	48	BRPVC-200-226-16/16
26	200	16	200	342	235	232	6	295	12	22	48	BRPVC-200-235-16/16
27	200	16	225	342	252	248	6	295	12	22	48	BRPVC-200-252-16/16
28	250	10	250	405	277	273	6	355	12	26	42	BRPVC-250-277-10/16
29	250	10	280	405	310	306	6	355	12	26	42	BRPVC-250-310-10/16
30	250	16	250	405	277	273	6	355	12	26	54	BRPVC-250-277-16/16
31	250	16	280	405	310	306	6	355	12	26	54	BRPVC-250-310-16/16
32	300	10	315	458	348	344	6	410	12	26	46	BRPVC-300-348-10/16
33	300	16	315	458	348	344	6	410	12	26	58	BRPVC-300-348-16/16

Disclaimer

Whilst every care is taken to ensure that the information on this website is complete and accurate, the Rotec Composite Group BV cannot accept responsibility for any omissions or inaccuracies or for any consequences arising therefrom. By using this website, the user accepts the terms of this disclaimer.

Rotec FRP Backing Rings

suitable for PVC Stub flange

Drilling Standard: EN1092 PN16

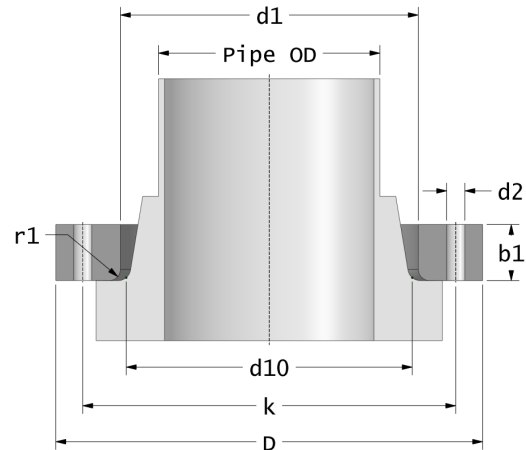

#	DN (mm)	Pmax (bar)	Pipe OD (mm)	D (mm)	d1 (mm)	d10 (mm)	r1 (mm)	k (mm)	Holes (no.)	d2 (mm)	b1 (mm)	Article Number
34	350	10	355	540	388	384	6	470	16	26	42	BRPVC-350-388-10/16
35	350	16	355	540	388	384	6	470	16	26	52	BRPVC-350-388-16/16
36	400	10	400	600	442	438	6	525	16	30	44	BRPVC-400-442-10/10
37	400	16	400	600	442	438	6	525	16	30	54	BRPVC-400-442-16/16

Disclaimer

Whilst every care is taken to ensure that the information on this website is complete and accurate, the Rotec Composite Group BV cannot accept responsibility for any omissions or inaccuracies or for any consequences arising therefrom. By using this website, the user accepts the terms of this disclaimer.

25-01-2024