

Rotec Backing Rings (Backing Ring by Hot Pressing)

Drilling Standard: EN1092 PN10, Pipe Type: PVC



#	DN (mm)	Pmax (bar)	Pipe OD (mm)	D (mm)	d1 (mm)	d10 (mm)	r1 (mm)	k (mm)	Holes (no.)	d2 (mm)	b1 (mm)	Article Number
1	15	16	20	98	28	27	3	65	4	14	15	BRP-15-28-16/16
2	20	16	25	116	34	33	3	75	4	14	15	BRP-20-34-16/16
3	25	16	32	116	42	40	3	85	4	14	15	BRP-25-42-16/16
4	32	16	40	140	51	50	3	100	4	18	16	BRP-32-51-16/16
5	40	16	50	154	62	61	3	110	4	18	18	BRP-40-62-16/16
6	40	16	50	154	78	75	3	110	4	18	18	BRP-40-78-16/16
7	50	16	63	164	78	75	4	125	4	18	18	BRP-50-78-16/16
8	65	16	63	184	78	75	4	145	4	18	20	BRP-65-78-16/16
9	65	16	75	184	92	89	4	145	4	18	20	BRP-65-92-16/16
10	80	10	75	200	92	89	4	160	8	18	23	BRP-80-92-10/16
11	80	16	75	200	92	89	4	160	8	18	28	BRP-80-92-16/16
12	80	10	90	200	112	111	4	160	8	18	23	BRP-80-112-10/16
13	80	16	90	200	112	111	4	160	8	18	28	BRP-80-112-16/16
14	100	10	90	228	112	111	5	180	8	18	25	BRP-100-112-10/16
15	100	16	90	228	112	111	5	180	8	18	30	BRP-100-112-16/16
16	100	10	125	228	134	133	5	180	8	18	25	BRP-100-134-10/16

Disclaimer

Whilst every care is taken to ensure that the information on this website is complete and accurate, the Rotec Composite Group BV cannot accept responsibility for any omissions or inaccuracies or for any consequences arising therefrom. By using this website, the user accepts the terms of this disclaimer.

Rotec Backing Rings (Backing Ring by Hot Pressing)

Drilling Standard: EN1092 PN10, Pipe Type: PVC



#	DN (mm)	Pmax (bar)	Pipe OD (mm)	D (mm)	d1 (mm)	d10 (mm)	r1 (mm)	k (mm)	Holes (no.)	d2 (mm)	b1 (mm)	Article Number
17	100	16	125	228	134	133	5	180	8	18	30	BRP-100-134-16/16
18	125	10	125	254	134	132	5	210	8	18	28	BRP-125-134-10/16
19	125	16	125	254	134	132	5	210	8	18	34	BRP-125-134-16/16
20	125	10	125	254	150	147	5	210	8	18	28	BRP-125-150-10/16
21	125	16	125	254	150	147	5	210	8	18	34	BRP-125-150-16/16
22	125	10	140	254	167	163	5	210	8	18	28	BRP-125-167-10/16
23	125	16	140	254	167	163	5	210	8	18	34	BRP-125-167-16/16
24	150	10	140	284	167	163	5	240	8	22	34	BRP-150-167-10/16
25	150	16	140	284	167	163	5	240	8	22	40	BRP-150-167-16/16
26	150	10	180	284	185	182	5	240	8	22	34	BRP-150-185-10/16
27	150	16	180	284	185	182	5	240	8	22	40	BRP-150-185-16/16
28	200	6	180	342	205	201	6	295	8	22	35	BRP-200-205-06/10
29	200	10	180	342	205	201	6	295	8	22	41	BRP-200-205-10/10
30	200	6	200	342	226	222	6	295	8	22	35	BRP-200-226-06/10
31	200	10	200	342	226	222	6	295	8	22	41	BRP-200-226-10/10
32	200	6	200	342	235	232	6	295	8	22	35	BRP-200-235-06/10
33	200	10	200	342	235	232	6	295	8	22	41	BRP-200-235-10/10

Disclaimer

Whilst every care is taken to ensure that the information on this website is complete and accurate, the Rotec Composite Group BV cannot accept responsibility for any omissions or inaccuracies or for any consequences arising therefrom. By using this website, the user accepts the terms of this disclaimer.

23-08-2024

Rotec Backing Rings (Backing Ring by Hot Pressing)

Drilling Standard: EN1092 PN10, Pipe Type: PVC

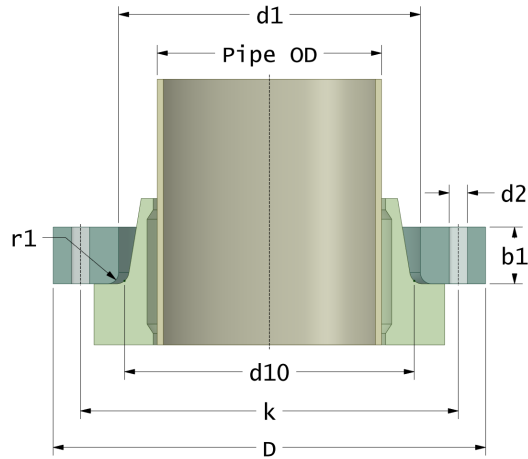

#	DN (mm)	Pmax (bar)	Pipe OD (mm)	D (mm)	d1 (mm)	d10 (mm)	r1 (mm)	k (mm)	Holes (no.)	d2 (mm)	b1 (mm)	Article Number
34	200	6	225	342	252	248	6	295	8	22	35	BRP-200-252-06/10
35	200	10	225	342	252	248	6	295	8	22	41	BRP-200-252-10/10
36	250	6	250	405	277	273	6	350	12	22	35	BRP-250-277-06/10
37	250	10	250	405	277	273	6	350	12	22	42	BRP-250-277-10/10
38	250	6	280	405	310	306	6	350	12	22	35	BRP-250-310-06/10
39	250	10	280	405	310	306	6	350	12	22	42	BRP-250-310-10/10
40	300	6	315	458	348	347	6	400	12	22	42	BRP-300-348-06/10
41	300	10	315	458	348	347	6	400	12	22	50	BRP-300-348-10/10

Disclaimer

Whilst every care is taken to ensure that the information on this website is complete and accurate, the Rotec Composite Group BV cannot accept responsibility for any omissions or inaccuracies or for any consequences arising therefrom. By using this website, the user accepts the terms of this disclaimer.

23-08-2024