

Rotec Backing Rings (Backing Ring for PE & PP Pipes)

Drilling Standard: ANSI B16.47 Class 150

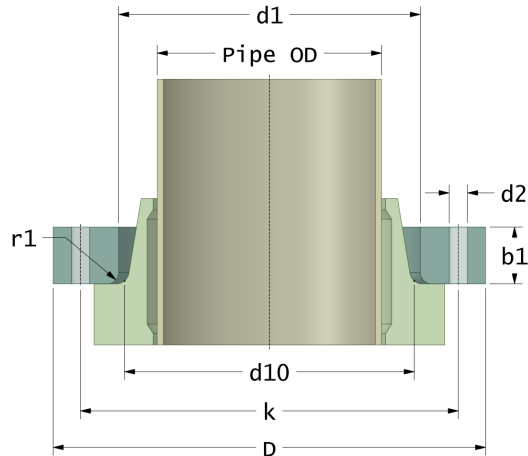

#	DN (mm)	Pmax (bar)	Pipe OD (mm)	D (mm)	d1 (mm)	d10 (mm)	r1 (mm)	k (mm)	Holes (no.)	d2 (mm)	b1 (mm)	Article Number
1	700	10	710	930	725	710	7	864	28	35	67	BR-700-725-10/150
2	700	10	710	930	740	737	7	864	28	35	67	BR-700-740-10/150
3	700	16	710	930	725	710	7	864	28	35	82	BR-700-725-16/150
4	700	16	710	930	740	737	7	864	28	35	82	BR-700-740-16/150
5	800	10	800	1085	815	800	7	978	28	41	73	BR-800-815-10/150
6	800	10	800	1085	843	840	7	978	28	41	73	BR-800-843-10/150
7	800	16	800	1085	815	800	7	978	28	41	88	BR-800-815-16/150
8	800	16	800	1085	843	840	7	978	28	41	88	BR-800-843-16/150
9	900	6	900	1190	915	900	7	1086	32	41	62	BR-900-915-06/150
10	900	6	900	1190	947	944	7	1086	32	41	62	BR-900-947-06/150
11	900	10	900	1190	915	900	7	1086	32	41	87	BR-900-915-10/150
12	900	10	900	1190	947	944	7	1086	32	41	87	BR-900-947-10/150
13	1000	6	1000	1320	1015	1000	7	1200	36	41	65	BR-1000-1015-06/150
14	1000	6	1000	1320	1050	1047	7	1200	36	41	65	BR-1000-1050-06/150
15	1000	10	1000	1320	1015	1000	7	1200	36	41	90	BR-1000-1015-10/150
16	1000	10	1000	1320	1050	1047	7	1200	36	41	90	BR-1000-1050-10/150

Disclaimer

Whilst every care is taken to ensure that the information on this website is complete and accurate, the Rotec Composite Group BV cannot accept responsibility for any omissions or inaccuracies or for any consequences arising therefrom. By using this website, the user accepts the terms of this disclaimer.

Rotec Backing Rings (Backing Ring for PE & PP Pipes)

Drilling Standard: ANSI B16.47 Class 150

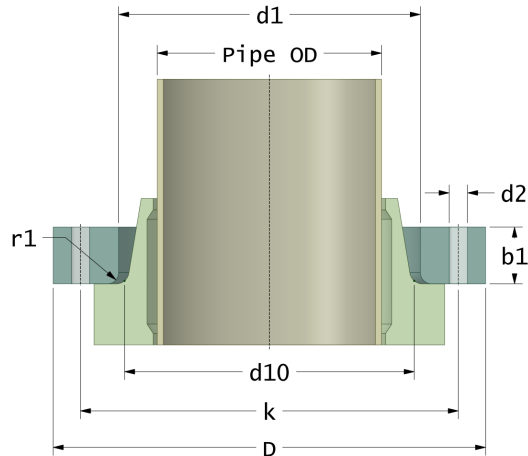

#	DN (mm)	Pmax (bar)	Pipe OD (mm)	D (mm)	d1 (mm)	d10 (mm)	r1 (mm)	k (mm)	Holes (no.)	d2 (mm)	b1 (mm)	Article Number
17	1200	6	1200	1520	1215	1200	8	1422	44	41	70	BR-1200-1215-06/150
18	1200	6	1200	1520	1250	1245	8	1422	44	41	70	BR-1200-1250-06/150
19	1200	10	1200	1520	1215	1200	8	1422	44	41	100	BR-1200-1215-10/150
20	1200	10	1200	1520	1250	1245	8	1422	44	41	100	BR-1200-1250-10/150

Disclaimer

Whilst every care is taken to ensure that the information on this website is complete and accurate, the Rotec Composite Group BV cannot accept responsibility for any omissions or inaccuracies or for any consequences arising therefrom. By using this website, the user accepts the terms of this disclaimer.

16-11-2022