

# Rotec Backing Rings (Backing Ring by Hot Pressing)

Drilling Standard: ANSI B16.5 Class 150, Pipe Type: PVC

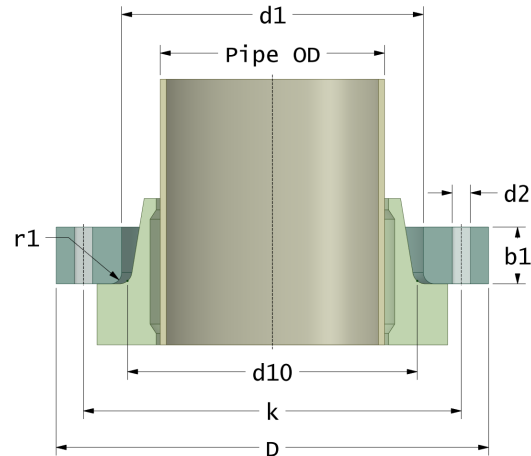
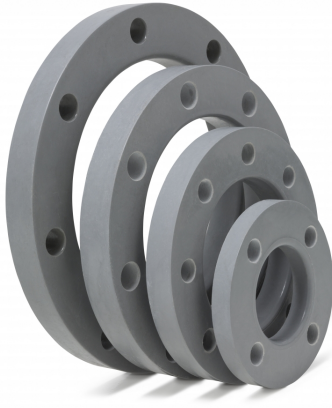

#	DN (mm)	Pmax (bar)	Pipe OD (mm)	D (mm)	d1 (mm)	d10 (mm)	r1 (mm)	k (mm)	Holes (no.)	d2 (mm)	b1 (mm)	Article Number
1	15	16	20	98	28	27	3	60	4	16	15	BRP-15-28-16/150
2	20	16	25	98	34	33	3	70	4	16	15	BRP-20-34-16/150
3	25	16	32	116	42	40	3	79	4	16	15	BRP-25-42-16/150
4	32	16	40	116	51	50	3	89	4	16	16	BRP-32-51-16/150
5	40	16	50	140	62	61	3	98	4	16	18	BRP-40-62-16/150
6	50	16	63	154	78	75	4	121	4	19	18	BRP-50-78-16/150
7	65	16	63	184	78	75	4	140	4	19	20	BRP-65-78-16/150
8	65	16	75	184	92	89	4	140	4	19	20	BRP-65-92-16/150
9	80	10	75	200	92	89	4	152	4	19	23	BRP-80-92-10/150
10	80	16	75	200	92	89	4	152	4	19	28	BRP-80-92-16/150
11	80	10	90	200	112	108	4	152	4	19	23	BRP-80-112-10/150
12	80	16	90	200	112	108	4	152	4	19	28	BRP-80-112-16/150
13	100	10	90	228	112	108	5	190	8	19	25	BRP-100-112-10/150
14	100	16	90	228	112	108	5	190	8	19	30	BRP-100-112-16/150
15	100	10	125	228	134	132	5	190	8	19	25	BRP-100-134-10/150
16	100	16	125	228	134	132	5	190	8	19	30	BRP-100-134-16/150

## Disclaimer

Whilst every care is taken to ensure that the information on this website is complete and accurate, the Rotec Composite Group BV cannot accept responsibility for any omissions or inaccuracies or for any consequences arising therefrom. By using this website, the user accepts the terms of this disclaimer.

# Rotec Backing Rings (Backing Ring by Hot Pressing)

Drilling Standard: ANSI B16.5 Class 150, Pipe Type: PVC

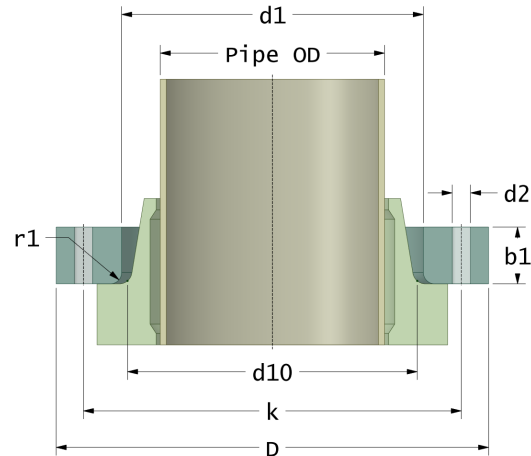

#	DN (mm)	Pmax (bar)	Pipe OD (mm)	D (mm)	d1 (mm)	d10 (mm)	r1 (mm)	k (mm)	Holes (no.)	d2 (mm)	b1 (mm)	Article Number
17	125	10	125	254	134	132	5	216	8	22	28	BRP-125-134-10/150
18	125	16	125	254	134	132	5	216	8	22	34	BRP-125-134-16/150
19	125	10	125	254	150	147	5	216	8	22	28	BRP-125-150-10/150
20	125	16	125	254	150	147	5	216	8	22	34	BRP-125-150-16/150
21	125	10	140	254	167	163	5	216	8	22	28	BRP-125-167-10/150
22	125	16	140	254	167	163	5	216	8	22	34	BRP-125-167-16/150
23	150	10	140	284	167	163	5	241	8	22	34	BRP-150-167-10/150
24	150	16	140	284	167	163	5	241	8	22	40	BRP-150-167-16/150
25	150	10	180	284	189	185	5	241	8	22	34	BRP-150-189-10/150
26	150	16	180	284	189	185	5	241	8	22	40	BRP-150-189-16/150
27	200	6	180	342	205	201	6	298	8	22	35	BRP-200-205-06/150
28	200	10	180	342	205	201	6	298	8	22	41	BRP-200-205-10/150
29	200	16	180	342	205	201	6	298	8	22	48	BRP-200-205-16/150
30	200	6	200	342	226	222	6	298	8	22	35	BRP-200-226-06/150
31	200	10	200	342	226	222	6	298	8	22	41	BRP-200-226-10/150
32	200	16	200	342	226	222	6	298	8	22	48	BRP-200-226-16/150
33	200	6	200	342	235	232	6	298	8	22	35	BRP-200-235-06/150

## Disclaimer

Whilst every care is taken to ensure that the information on this website is complete and accurate, the Rotec Composite Group BV cannot accept responsibility for any omissions or inaccuracies or for any consequences arising therefrom. By using this website, the user accepts the terms of this disclaimer.

23-10-2022

# Rotec Backing Rings (Backing Ring by Hot Pressing)

Drilling Standard: ANSI B16.5 Class 150, Pipe Type: PVC

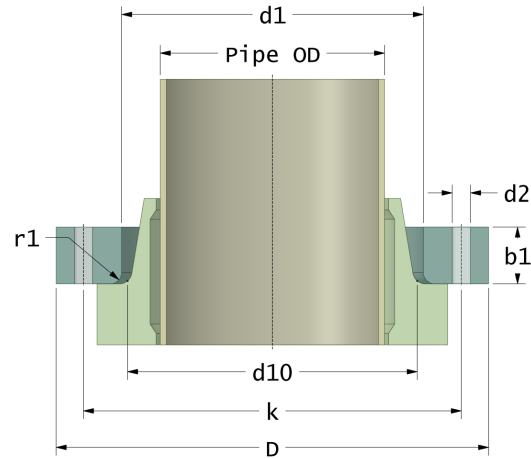
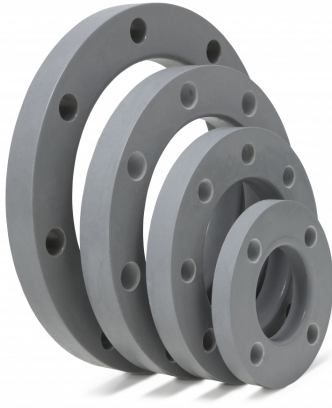

#	DN (mm)	Pmax (bar)	Pipe OD (mm)	D (mm)	d1 (mm)	d10 (mm)	r1 (mm)	k (mm)	Holes (no.)	d2 (mm)	b1 (mm)	Article Number
34	200	10	200	342	235	232	6	298	8	22	41	BRP-200-235-10/150
35	200	16	200	342	235	232	6	298	8	22	48	BRP-200-235-16/150
36	200	6	225	342	252	247	6	298	8	22	35	BRP-200-252-06/150
37	200	10	225	342	252	247	6	298	8	22	41	BRP-200-252-10/150
38	200	16	225	342	252	247	6	298	8	22	48	BRP-200-252-16/150
39	250	6	250	405	277	273	6	362	12	26	35	BRP-250-277-06/150
40	250	10	250	405	277	273	6	362	12	26	42	BRP-250-277-10/150
41	250	6	280	405	310	306	6	362	12	26	35	BRP-250-310-06/150
42	250	10	280	405	310	306	6	362	12	26	42	BRP-250-310-10/150
43	300	6	315	485	348	344	6	432	12	26	42	BRP-300-348-06/150
44	300	10	315	485	348	344	6	432	12	26	62	BRP-300-348-10/150

## Disclaimer

Whilst every care is taken to ensure that the information on this website is complete and accurate, the Rotec Composite Group BV cannot accept responsibility for any omissions or inaccuracies or for any consequences arising therefrom. By using this website, the user accepts the terms of this disclaimer.

23-10-2022