

Losflansche (Loser Flansche)

Typ BRP and BR / geeignet für GFK Bund (Typ TSS/TSC & SF Rotec)

Drilling Standard: EN1092 PN16



#	DN (mm)	Pmax (bar)	D (mm)	d1 (mm)	d10 (mm)	r1 (mm)	k (mm)	Holes (no.)	d2 (mm)	b1 (mm)	Resin Type	Product Color	Article Number
1	15	16	98	34	33	3	65	4	14	15	Vinylester	Off-White	BRP-15-34-16/16
2	25	16	116	51	50	3	85	4	14	15	Vinylester	Off-White	BRP-25-51-16/16
3	32	16	140	59	58	3	100	4	18	16	Vinylester	Off-White	BRP-32-59-16/16
4	40	16	154	69	68	3	110	4	18	18	Vinylester	Off-White	BRP-40-69-16/16
5	50	16	164	83	82	4	125	4	18	18	Vinylester	Off-White	BRP-50-83-16/16
6	65	16	184	96	95	4	145	4	18	20	Vinylester	Off-White	BRP-65-96-16/16
7	80	10	200	112	111	4	160	8	18	23	Vinylester	Off-White	BRP-80-112-10/16
8	80	16	200	112	111	4	160	8	18	28	Vinylester	Off-White	BRP-80-112-16/16
9	100	10	228	134	133	5	180	8	18	25	Vinylester	Off-White	BRP-100-134-10/16
10	100	16	228	134	133	5	180	8	18	30	Vinylester	Off-White	BRP-100-134-16/16
11	125	10	254	161	160	5	210	8	18	28	Vinylester	Off-White	BRP-125-161-10/16
12	125	16	254	161	160	5	210	8	18	34	Vinylester	Off-White	BRP-125-161-16/16
13	150	10	284	189	188	5	240	8	22	34	Vinylester	Off-White	BRP-150-189-10/16
14	150	16	284	189	188	5	240	8	22	40	Vinylester	Off-White	BRP-150-189-16/16
15	200	10	342	238	237	6	295	12	22	38	Vinylester	Off-White	BRP-200-238-10/16
16	200	16	342	238	237	6	295	12	22	48	Vinylester	Off-White	BRP-200-238-16/16
17	250	10	405	294	293	6	355	12	26	42	Vinylester	Off-White	BRP-250-294-10/16
18	250	16	405	294	293	6	355	12	26	54	Vinylester	Off-White	BRP-250-294-16/16
19	300	6	458	344	343	6	410	12	26	38	Vinylester	Off-White	BRP-300-344-06/16

Disclaimer

Whilst every care is taken to ensure that the information on this website is complete and accurate, the Rotec Composite Group BV cannot accept responsibility for any omissions or inaccuracies or for any consequences arising therefrom. By using this website, the user accepts the terms of this disclaimer.

Losflansche (Loser Flansche)

Typ BRP and BR / geeignet für GFK Bund (Typ TSS/TSC & SF Rotec)

Drilling Standard: EN1092 PN16



#	DN (mm)	Pmax (bar)	D (mm)	d1 (mm)	d10 (mm)	r1 (mm)	k (mm)	Holes (no.)	d2 (mm)	b1 (mm)	Resin Type	Product Color	Article Number
20	300	10	458	344	343	6	410	12	26	48	Vinylester	Off-White	BRP-300-344-10/16
21	350	10	520	402	398	6	470	16	26	38	Vinylester	Grey	BR-350-402-10/16
22	350	16	520	402	398	6	470	16	26	48	Vinylester	Grey	BR-350-402-16/16
23	400	10	585	455	451	6	525	16	30	42	Vinylester	Grey	BR-400-455-10/16
24	400	16	585	455	451	6	525	16	30	54	Vinylester	Grey	BR-400-455-16/16
25	450	16	640	508	503	6	585	20	30	65	Vinylester	Grey	BR-450-508-16/16
26	500	10	715	560	556	6	650	20	33	55	Vinylester	Grey	BR-500-560-10/16
27	500	16	715	560	556	6	650	20	33	70	Vinylester	Grey	BR-500-560-16/16
28	600	10	840	668	664	7	770	20	36	62	Vinylester	Grey	BR-600-668-10/16
29	600	16	840	668	664	7	770	20	36	78	Vinylester	Grey	BR-600-668-16/16
30	700	10	910	762	756	7	840	24	36	64	Vinylester	Grey	BR-700-762-10/16
31	700	16	910	762	756	7	840	24	36	82	Vinylester	Grey	BR-700-762-16/16
32	800	10	1025	867	861	7	950	24	39	70	Vinylester	Grey	BR-800-867-10/16
33	800	16	1025	867	861	7	950	24	39	88	Vinylester	Grey	BR-800-867-16/16
34	900	10	1125	973	967	7	1050	28	39	82	Vinylester	Grey	BR-900-973-10/16
35	900	16	1125	973	967	7	1050	28	39	110	Vinylester	Grey	BR-900-973-16/16
36	1000	10	1255	1076	1070	7	1170	28	42	87	Vinylester	Grey	BR-1000-1076-10/16
37	1200	10	1484	1284	1278	8	1390	32	48	90	Vinylester	Grey	BR-1200-1284-10/16
38	1400	10	1685	1504	1486	8	1590	36	48	112	Vinylester	Grey	BR-1400-1492-10/16

Disclaimer

Whilst every care is taken to ensure that the information on this website is complete and accurate, the Rotec Composite Group BV cannot accept responsibility for any omissions or inaccuracies or for any consequences arising therefrom. By using this website, the user accepts the terms of this disclaimer.

Losflansche (Loser Flansche)

Typ BRP and BR / geeignet für GFK Bund (Typ TSS/TSC & SF Rotec)

Drilling Standard: EN1092 PN16

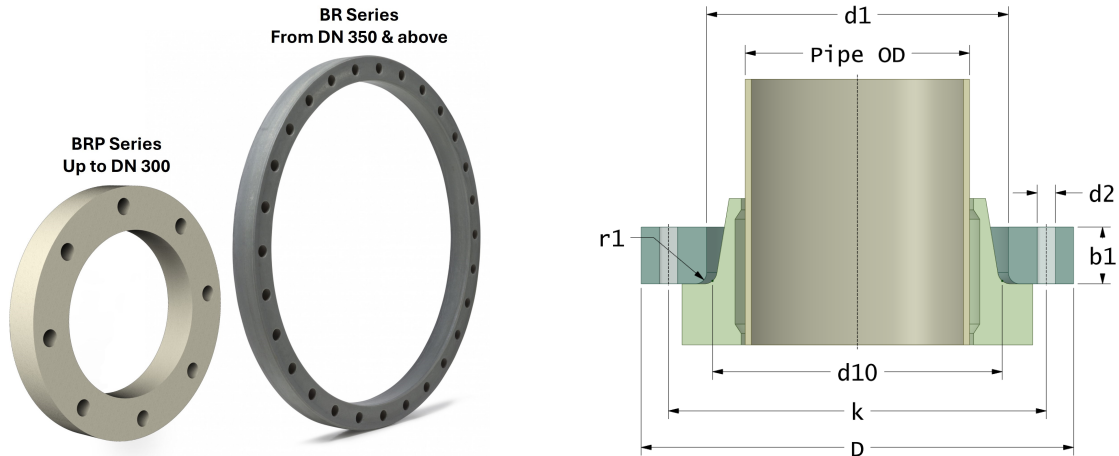

#	DN (mm)	Pmax (bar)	D (mm)	d1 (mm)	d10 (mm)	r1 (mm)	k (mm)	Holes (no.)	d2 (mm)	b1 (mm)	Resin Type	Product Color	Article Number
39	1600	10	1930	1704	1696	8	1820	40	56	140	Vinylester	Grey	BR-1600-1704-10/16

Disclaimer

Whilst every care is taken to ensure that the information on this website is complete and accurate, the Rotec Composite Group BV cannot accept responsibility for any omissions or inaccuracies or for any consequences arising therefrom. By using this website, the user accepts the terms of this disclaimer.

28-05-2026