

## Losflansche (Loser Flansche)

Typ BRP and BR / geeignet für GFK Bund (Typ TSS/TSC & SF Rotec)

Drilling Standard: EN1092 PN10



#	DN (mm)	Pmax (bar)	D (mm)	d1 (mm)	d10 (mm)	r1 (mm)	k (mm)	Holes (no.)	d2 (mm)	b1 (mm)	Resin Type	Product Color	Article Number
1	15	16	98	34	33	3	65	4	14	15	Vinylester	Off-White	BRP-15-34-16/16
2	25	16	116	51	50	3	85	4	14	15	Vinylester	Off-White	BRP-25-51-16/16
3	32	16	140	59	58	3	100	4	18	16	Vinylester	Off-White	BRP-32-59-16/16
4	40	16	154	69	68	3	110	4	18	18	Vinylester	Off-White	BRP-40-69-16/16
5	50	16	164	83	82	4	125	4	18	18	Vinylester	Off-White	BRP-50-83-16/16
6	65	16	184	96	95	4	145	4	18	20	Vinylester	Off-White	BRP-65-96-16/16
7	80	10	200	112	111	4	160	8	18	23	Vinylester	Off-White	BRP-80-112-10/16
8	100	6	228	134	133	5	180	8	18	20	Vinylester	Off-White	BRP-100-134-06/16
9	100	10	228	134	133	5	180	8	18	25	Vinylester	Off-White	BRP-100-134-10/16
10	125	6	254	161	160	5	210	8	18	22	Vinylester	Off-White	BRP-125-161-06/16
11	125	10	254	161	160	5	210	8	18	28	Vinylester	Off-White	BRP-125-161-10/16
12	150	6	284	189	188	5	240	8	22	25	Vinylester	Off-White	BRP-150-189-06/16
13	150	10	284	189	188	5	240	8	22	34	Vinylester	Off-White	BRP-150-189-10/16
14	200	6	342	238	237	6	295	8	22	32	Vinylester	Off-White	BRP-200-238-06/10
15	200	10	342	238	237	6	295	8	22	38	Vinylester	Off-White	BRP-200-238-10/10
16	250	6	405	294	293	6	350	12	22	34	Vinylester	Off-White	BRP-250-294-06/10
17	250	10	405	294	293	6	350	12	22	42	Vinylester	Off-White	BRP-250-294-10/10
18	300	6	458	344	343	6	400	12	22	38	Vinylester	Off-White	BRP-300-344-06/10
19	300	10	458	344	343	6	400	12	22	48	Vinylester	Off-White	BRP-300-344-10/10

### Disclaimer

Whilst every care is taken to ensure that the information on this website is complete and accurate, the Rotec Composite Group BV cannot accept responsibility for any omissions or inaccuracies or for any consequences arising therefrom. By using this website, the user accepts the terms of this disclaimer.

## Losflansche (Loser Flansche)

Typ BRP and BR / geeignet für GFK Bund (Typ TSS/TSC & SF Rotec)

Drilling Standard: EN1092 PN10



#	DN (mm)	Pmax (bar)	D (mm)	d1 (mm)	d10 (mm)	r1 (mm)	k (mm)	Holes (no.)	d2 (mm)	b1 (mm)	Resin Type	Product Color	Article Number
20	350	10	505	402	398	6	460	16	22	38	Vinylester	Grey	BR-350-402-10/10
21	400	10	585	455	451	6	515	16	26	42	Vinylester	Grey	BR-400-455-10/10
22	450	10	640	508	503	6	565	20	26	50	Vinylester	Grey	BR-450-508-10/10
23	500	3	670	560	556	6	620	20	26	35	Vinylester	Grey	BR-500-560-03/10
24	500	10	670	560	556	6	620	20	26	50	Vinylester	Grey	BR-500-560-10/10
25	600	3	780	653	646	7	725	20	30	38	Vinylester	Grey	BR-600-653-03/10
26	600	10	780	653	646	7	725	20	30	58	Vinylester	Grey	BR-600-653-10/10
27	700	3	910	762	756	7	840	24	30	44	Vinylester	Grey	BR-700-762-03/10
28	700	10	910	762	756	7	840	24	30	64	Vinylester	Grey	BR-700-762-10/10
29	800	3	1015	867	861	7	950	24	33	45	Vinylester	Grey	BR-800-867-03/10
30	800	10	1015	867	861	7	950	24	33	70	Vinylester	Grey	BR-800-867-10/10
31	900	3	1125	973	967	7	1050	28	33	45	Vinylester	Grey	BR-900-973-03/10
32	900	6	1125	973	967	7	1050	28	33	65	Vinylester	Grey	BR-900-973-06/10
33	900	10	1125	973	967	7	1050	28	33	82	Vinylester	Grey	BR-900-973-10/10
34	1000	3	1255	1076	1070	7	1160	28	36	48	Vinylester	Grey	BR-1000-1076-03/10
35	1000	6	1255	1076	1070	7	1160	28	36	70	Vinylester	Grey	BR-1000-1076-06/10
36	1000	10	1255	1076	1070	7	1160	28	36	87	Vinylester	Grey	BR-1000-1076-10/10
37	1200	3	1484	1284	1278	8	1380	32	39	50	Vinylester	Grey	BR-1200-1284-03/10
38	1200	6	1484	1284	1278	8	1380	32	39	75	Vinylester	Grey	BR-1200-1284-06/10

### Disclaimer

Whilst every care is taken to ensure that the information on this website is complete and accurate, the Rotec Composite Group BV cannot accept responsibility for any omissions or inaccuracies or for any consequences arising therefrom. By using this website, the user accepts the terms of this disclaimer.

## Losflansche (Loser Flansche)

Typ BRP and BR / geeignet für GFK Bund (Typ TSS/TSC & SF Rotec)

Drilling Standard: EN1092 PN10

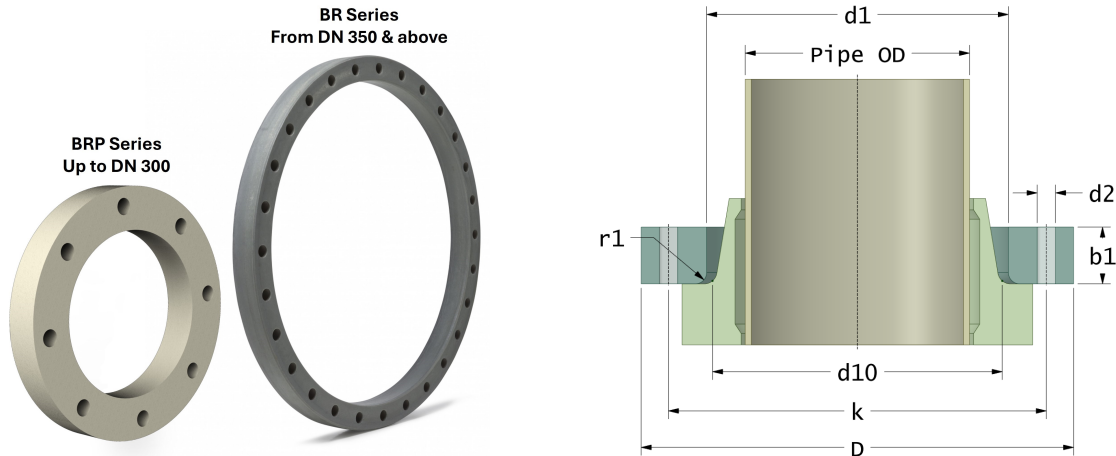

#	DN (mm)	Pmax (bar)	D (mm)	d1 (mm)	d10 (mm)	r1 (mm)	k (mm)	Holes (no.)	d2 (mm)	b1 (mm)	Resin Type	Product Color	Article Number
39	1200	10	1484	1284	1278	8	1380	32	39	90	Vinylester	Grey	BR-1200-1284-10/10
40	1400	3	1685	1504	1486	8	1590	36	42	60	Vinylester	Grey	BR-1400-1492-03/10
41	1400	6	1685	1504	1486	8	1590	36	42	90	Vinylester	Grey	BR-1400-1492-06/10
42	1400	10	1685	1504	1486	8	1590	36	42	112	Vinylester	Grey	BR-1400-1492-10/10
43	1600	3	1930	1704	1696	8	1820	40	48	70	Vinylester	Grey	BR-1600-1704-03/10
44	1600	6	1930	1704	1696	8	1820	40	48	90	Vinylester	Grey	BR-1600-1704-06/10
45	1600	10	1930	1704	1696	8	1820	40	48	140	Vinylester	Grey	BR-1600-1704-10/10
46	2000	3	2360	2126	2114	10	2230	48	48	80	Vinylester	Grey	BR-2000-2126-03/10
47	2000	6	2360	2126	2114	10	2230	48	48	110	Vinylester	Grey	BR-2000-2126-06/10
48	2000	10	2360	2126	2114	10	2230	48	48	155	Vinylester	Grey	BR-2000-2126-10/10
49	2200	3	2580	2312	2301	12	2440	52	56	66	Vinylester	Grey	BR-2200-2338-03/10
50	2200	6	2580	2312	2301	12	2440	52	56	100	Vinylester	Grey	BR-2200-2338-06/10
51	2200	10	2580	2312	2301	12	2440	52	56	134	Vinylester	Grey	BR-2200-2312-10/10
52	2400	3	2780	2522	2510	18	2650	56	56	95	Vinylester	Grey	BR-2400-2522-03/10
53	2400	6	2780	2522	2510	18	2650	56	56	130	Vinylester	Grey	BR-2400-2522-06/10
54	2400	10	2780	2522	2510	18	2650	56	56	170	Vinylester	Grey	BR-2400-2522-10/10

### Disclaimer

Whilst every care is taken to ensure that the information on this website is complete and accurate, the Rotec Composite Group BV cannot accept responsibility for any omissions or inaccuracies or for any consequences arising therefrom. By using this website, the user accepts the terms of this disclaimer.