

Losflansche (Loser Flansche)

Typ BRP and BR / geeignet für GFK Bund (Typ TSS/TSC & SF Rotec)

Drilling Standard: AS 2129 Table F

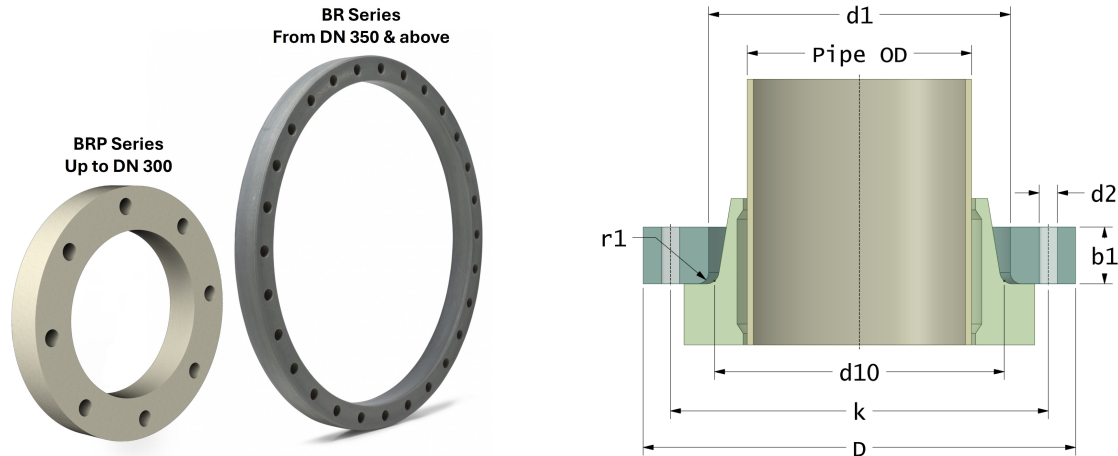

#	DN (mm)	Pmax (bar)	D (mm)	d1 (mm)	d10 (mm)	r1 (mm)	k (mm)	Holes (no.)	d2 (mm)	b1 (mm)	Resin Type	Product Color	Article Number
1	350	20	585	410	406	5	495	16	30	58	Vinylester	Grey	BR-350-410-20/AS-F
2	350	25	585	410	406	5	495	16	30	66	Vinylester	Grey	BR-350-410-25/AS-F
3	350	32	585	410	406	5	495	16	30	75	Vinylester	Grey	BR-350-410-32/AS-F
4	400	20	640	462	458	6	552	20	30	62	Vinylester	Grey	BR-400-462-20/AS-F
5	400	25	640	462	458	6	552	20	30	70	Vinylester	Grey	BR-400-462-25/AS-F
6	400	32	640	462	458	6	552	20	30	80	Vinylester	Grey	BR-400-462-32/AS-F
7	450	20	680	514	510	6	610	20	33	60	Vinylester	Grey	BR-450-514-20/AS-F
8	450	25	710	514	510	6	610	20	33	74	Vinylester	Grey	BR-450-514-25/AS-F
9	450	32	710	514	510	6	610	20	33	85	Vinylester	Grey	BR-450-514-32/AS-F
10	500	25	775	574	570	8	673	24	33	82	Vinylester	Grey	BR-500-574-25/AS-F
11	600	20	850	664	660	8	781	24	36	78	Vinylester	Grey	BR-600-664-20/AS-F
12	600	25	850	664	660	8	781	24	36	90	Vinylester	Grey	BR-600-664-25/AS-F
13	630	20	850	687	681	8	781	24	36	89	Vinylester	Grey	BR-630-687-20/AS-F
14	630	25	850	687	681	8	781	24	36	97	Vinylester	Grey	BR-630-687-25/AS-F
15	700	20	960	764	760	8	857	24	36	84	Vinylester	Grey	BR-700-764-20/AS-F
16	700	25	960	764	760	8	857	24	36	98	Vinylester	Grey	BR-700-764-25/AS-F
17	800	20	1085	878	874	9	984	28	36	90	Vinylester	Grey	BR-800-878-20/AS-F
18	800	25	1085	878	874	9	984	28	36	106	Vinylester	Grey	BR-800-878-25/AS-F
19	900	20	1200	974	970	9	1105	32	39	100	Vinylester	Grey	BR-900-974-20/AS-F

Disclaimer

Whilst every care is taken to ensure that the information on this website is complete and accurate, the Rotec Composite Group BV cannot accept responsibility for any omissions or inaccuracies or for any consequences arising therefrom. By using this website, the user accepts the terms of this disclaimer.

28-05-2026

Losflansche (Loser Flansche)

Typ BRP and BR / geeignet für GFK Bund (Typ TSS/TSC & SF Rotec)

Drilling Standard: AS 2129 Table F



#	DN (mm)	Pmax (bar)	D (mm)	d1 (mm)	d10 (mm)	r1 (mm)	k (mm)	Holes (no.)	d2 (mm)	b1 (mm)	Resin Type	Product Color	Article Number
20	900	25	1200	974	970	9	1105	32	39	118	Vinylester	Grey	BR-900-974-25/AS-F
21	1200	20	1540	1292	1286	10	1441	40	42	120	Vinylester	Grey	BR-1200-1292-20/AS-F

Disclaimer

Whilst every care is taken to ensure that the information on this website is complete and accurate, the Rotec Composite Group BV cannot accept responsibility for any omissions or inaccuracies or for any consequences arising therefrom. By using this website, the user accepts the terms of this disclaimer.